



Single impeller centrifugal pumps, from medium to high flow rate with 2", 3" and 4" delivery openings, mainly used in agriculture and applications requiring high level flow rate.

Construction features

Pump body	cast iron
Motor bracket	cast iron
Impeller	cast iron or brass (SDB)
Mechanical seal	ceramic-graphite-NBR
Motor shaft	stainless steel AISI 303 stainless steel AISI 416 (SD 75÷120)
Liquid temperature	0 - 90 °C
Operating pressure	max 6 bar

Motor

	3~ 230/400V-50Hz
2 Poles induction motor	1~ 230V-50Hz (with thermal protection up to MEC 80)
Insulation class	F
Protection degree	IPX4

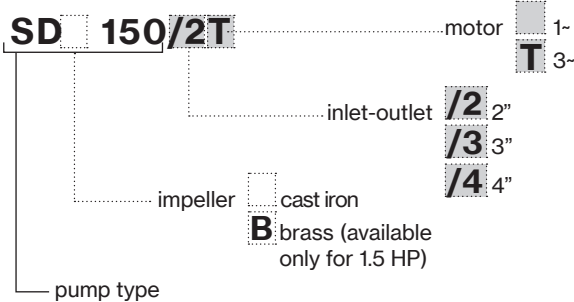

TYPE	LOTS			
	TRUCK		CONTAINER	
	PALLET (cm)	N° pumps	PALLET (cm)	N° pumps
SD 80/2-120/2	90×110×145	65	90×110×195	91
SD 150/2-200/2	85×110×140	40	85×110×205	60
SD 200/3-300/3	85×110×150	30	85×110×180	60
SD 400/4-550/4	80×120×150	30	80×120×180	60

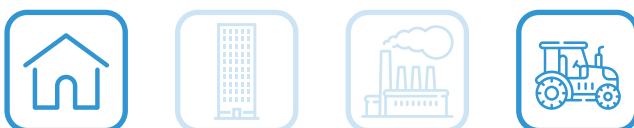
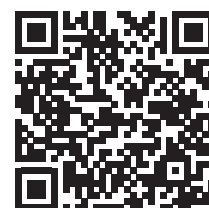

SD

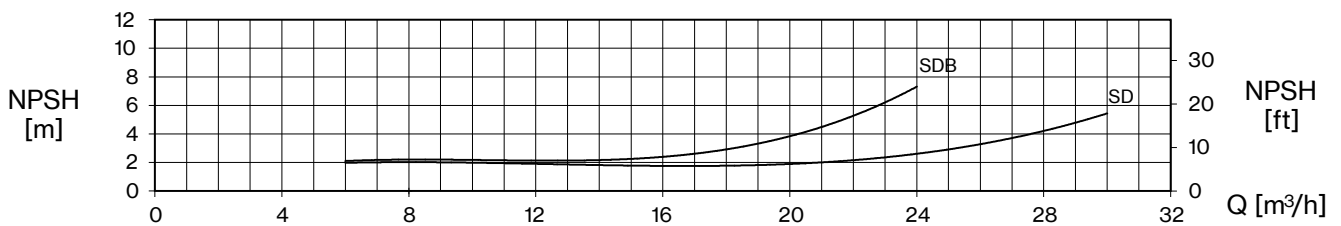
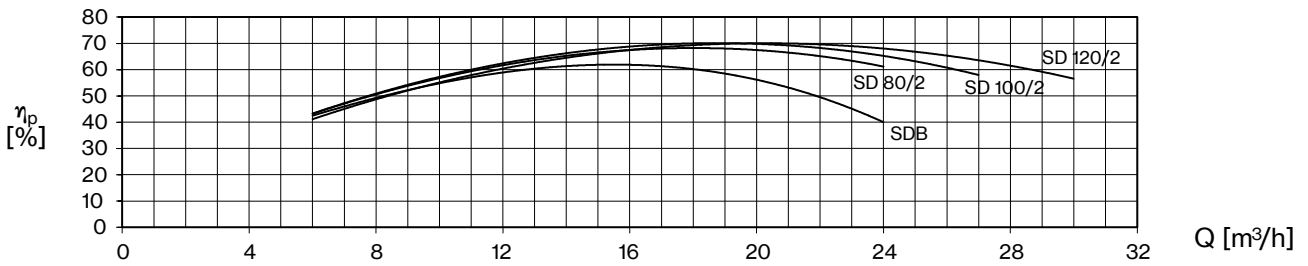
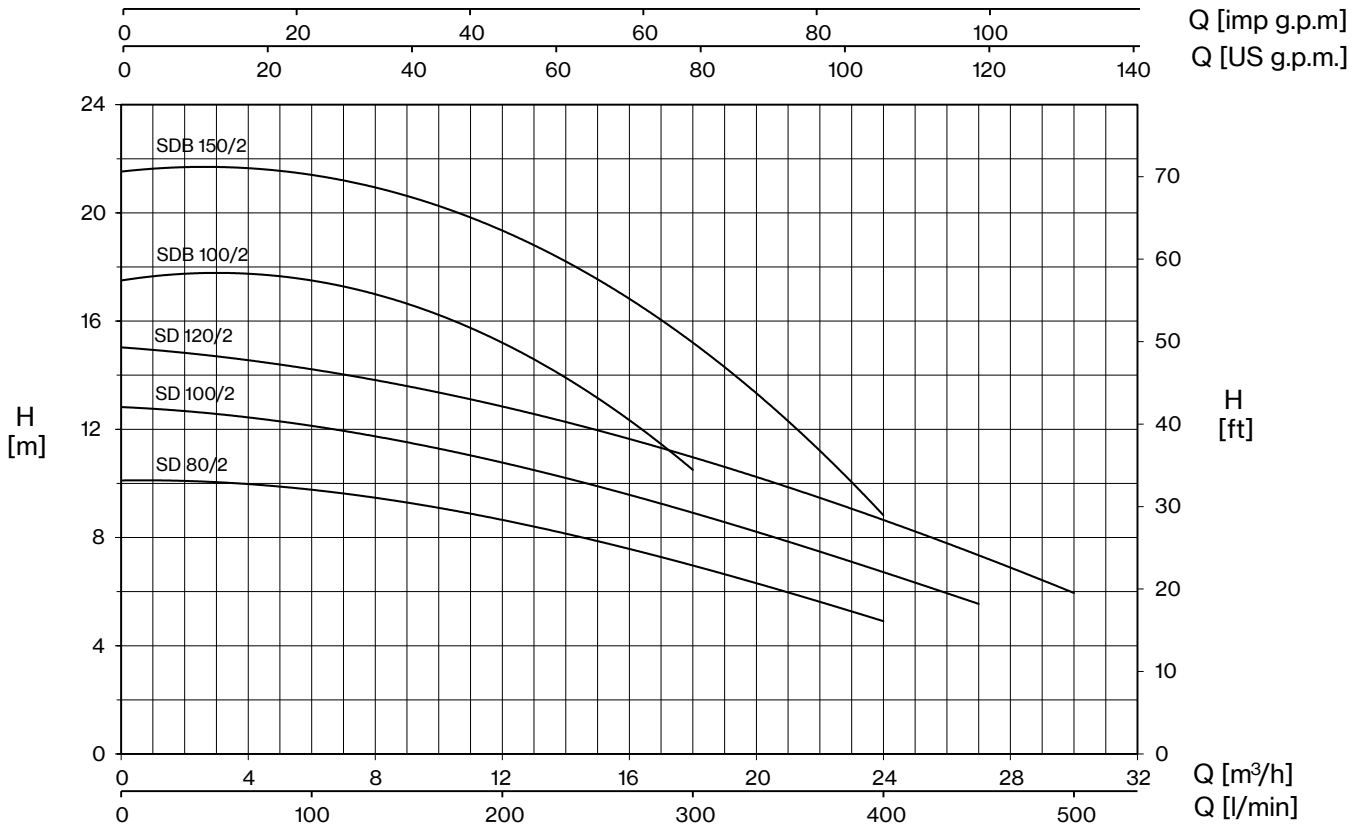

TYPE		P2		P1 (kW)		AMPERE		Q (m³/h - l/min)						
1~	3~					1~	3~	0	6	12	18	24	27	30
		HP	kW	1~	3~	1x230 V 50 Hz	3x400 V 50 Hz	H (m)						
SD 80/2	SD 80/2 T	0,8	0,59	0,8	0,7	3,5	1,3	10,1	9,8	8,6	7,0	4,9		
SD 100/2	SD 100/2 T	1	0,74	1,0	0,85	4,5	1,6	12,8	12,2	10,7	8,9	6,8	5,5	
SD 120/2	SD 120/2 T	1,2	0,9	1,2	1,1	5,4	2	15,0	14,3	12,8	10,9	8,7	7,4	5,9
SDB 100/2	-	1	0,74	1,23	-	6,0	-	17,5	17,5	15,2	10,5			
SDB 150/2	SDB 150/2 T	1,5	1,1	1,78	1,65	8,5	3	21,5	21,5	19,2	15,3	8,8		

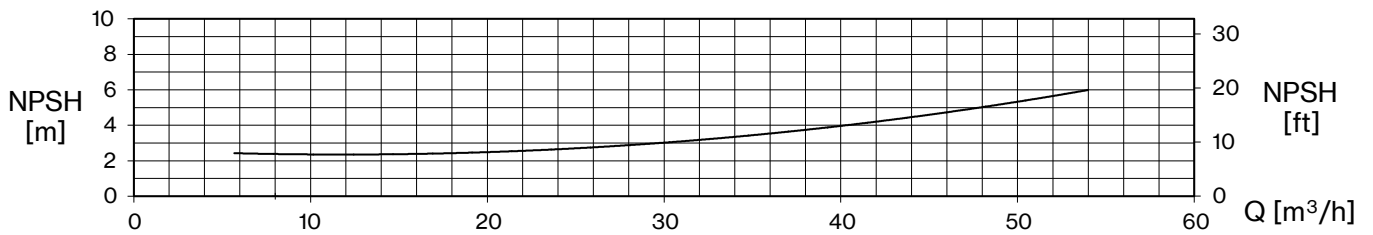
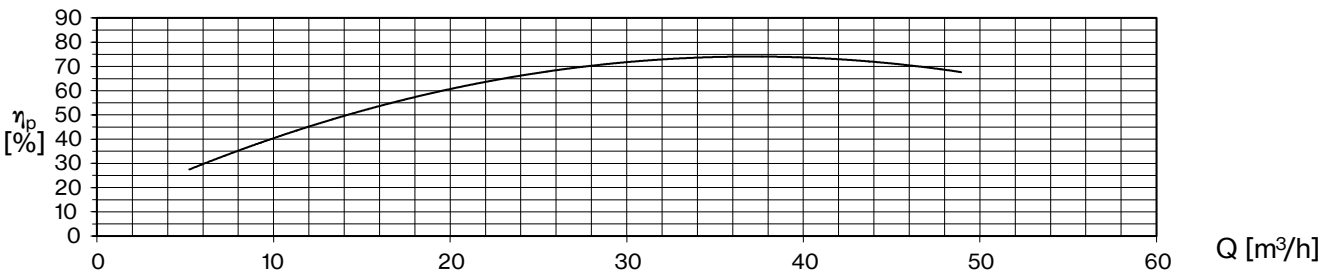
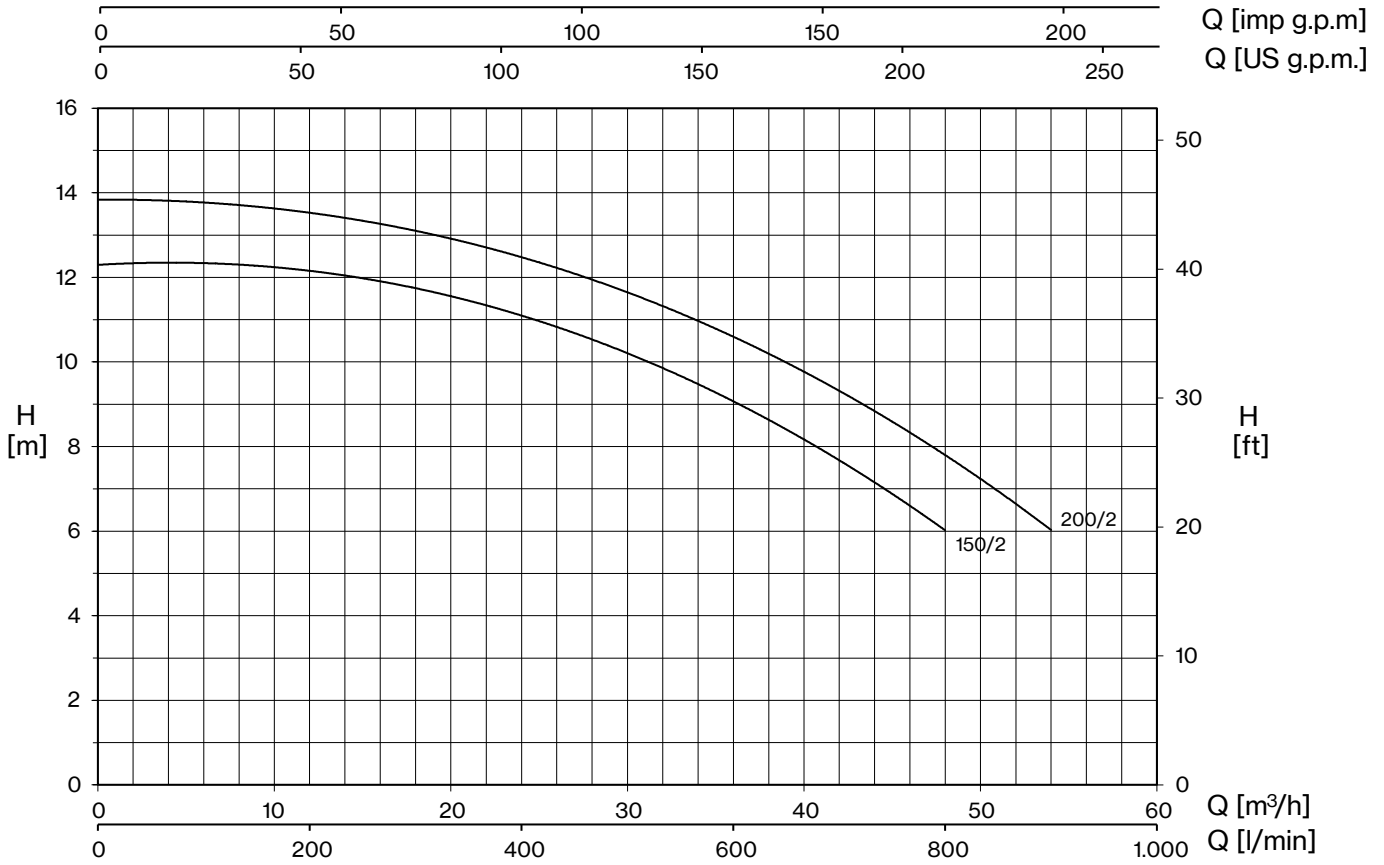

TYPE		P2		P1 (kW)		AMPERE		Q (m³/h - l/min)									
1~	3~	HP	kW	1~	3~	1~	3~	0	6	12	18	24	30	36	42	48	54
								0	100	200	300	400	500	600	700	800	900
						1x230 V 50 Hz	3x400 V 50 Hz	H (m)									
SD 150/2	SD 150/2 T	1,5	1,1	1,85	1,8	8,8	3,3	12,3	12,3	12,2	11,8	11,0	10,2	9,1	7,7	6	
SD 200/2	SD 200/2 T	2	1,5	2,1	2,1	10	3,9	13,8	13,8	13,6	13,1	12,4	11,6	10,6	9,4	7,8	6,0

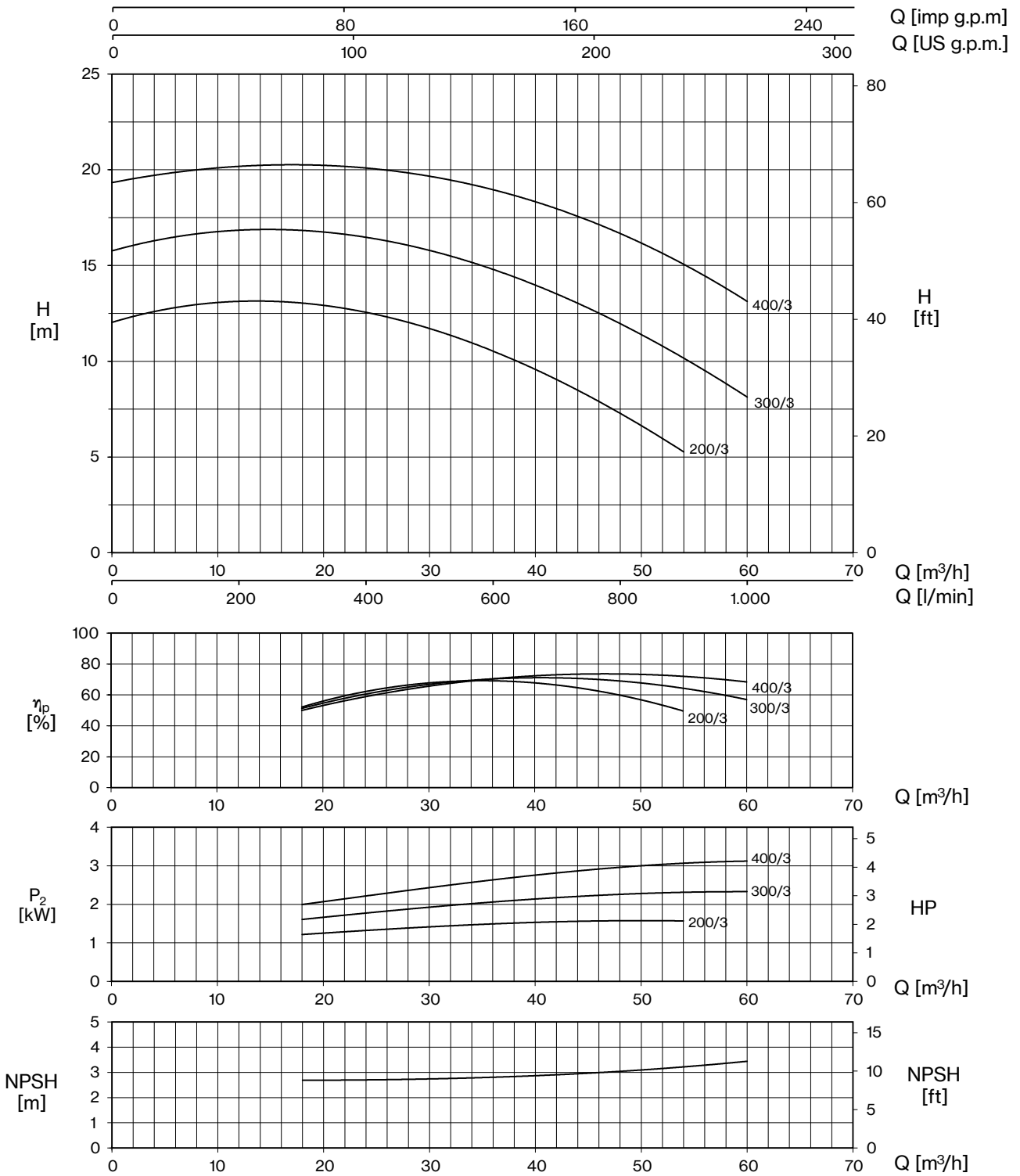

TYPE		P2	P1 (kW)		AMPERE		Q (m³/h - l/min)									
1~	3~		HP	kW	1~	3~	0	18	24	30	36	42	48	54	60	
						1x230 V 50 Hz	3x400 V 50 Hz	0	300	400	500	600	700	800	900	1000
						H (m)										
SD 200/3	SD 200/3 T	2	1,5	1,9	1,9	8,9	3,5	12,0	13,0	12,6	11,8	10,6	9,0	7,2	5,3	
SD 300/3	SD 300/3 T	3	2,2	2,7	2,7	12,4	5,0	15,8	16,8	16,5	15,7	14,7	13,6	12,0	10,1	8,2
-	SD 400/3 T	4	3	-	3,6	-	6,6	19,3	20,3	20,1	19,6	18,9	18,0	16,8	15,0	13,1

Q [imp g.p.m.]
Q [US g.p.m.]

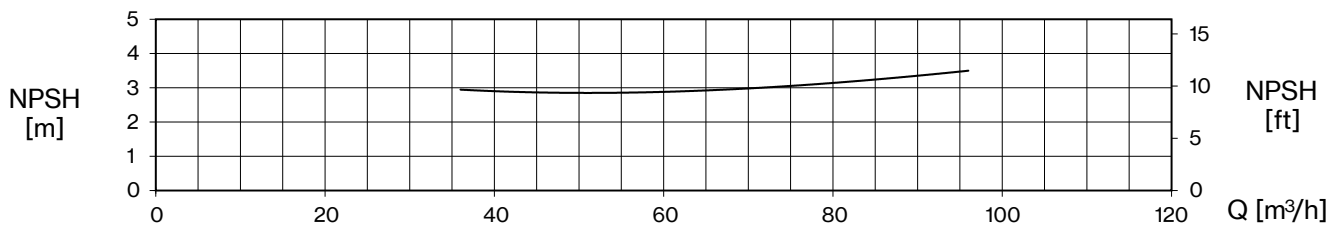
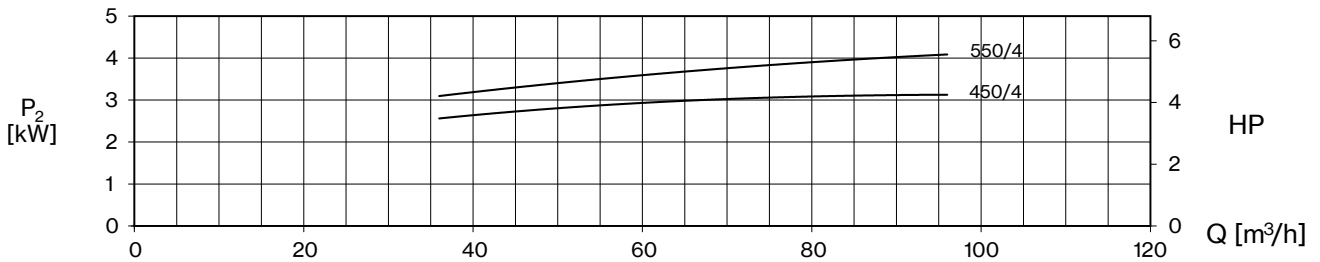
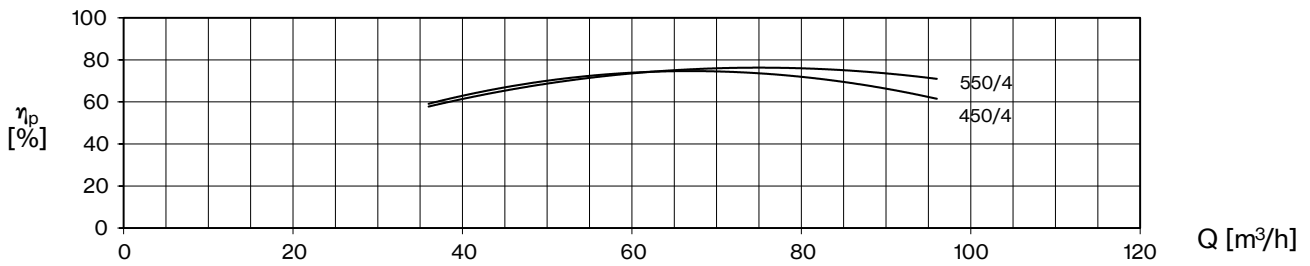
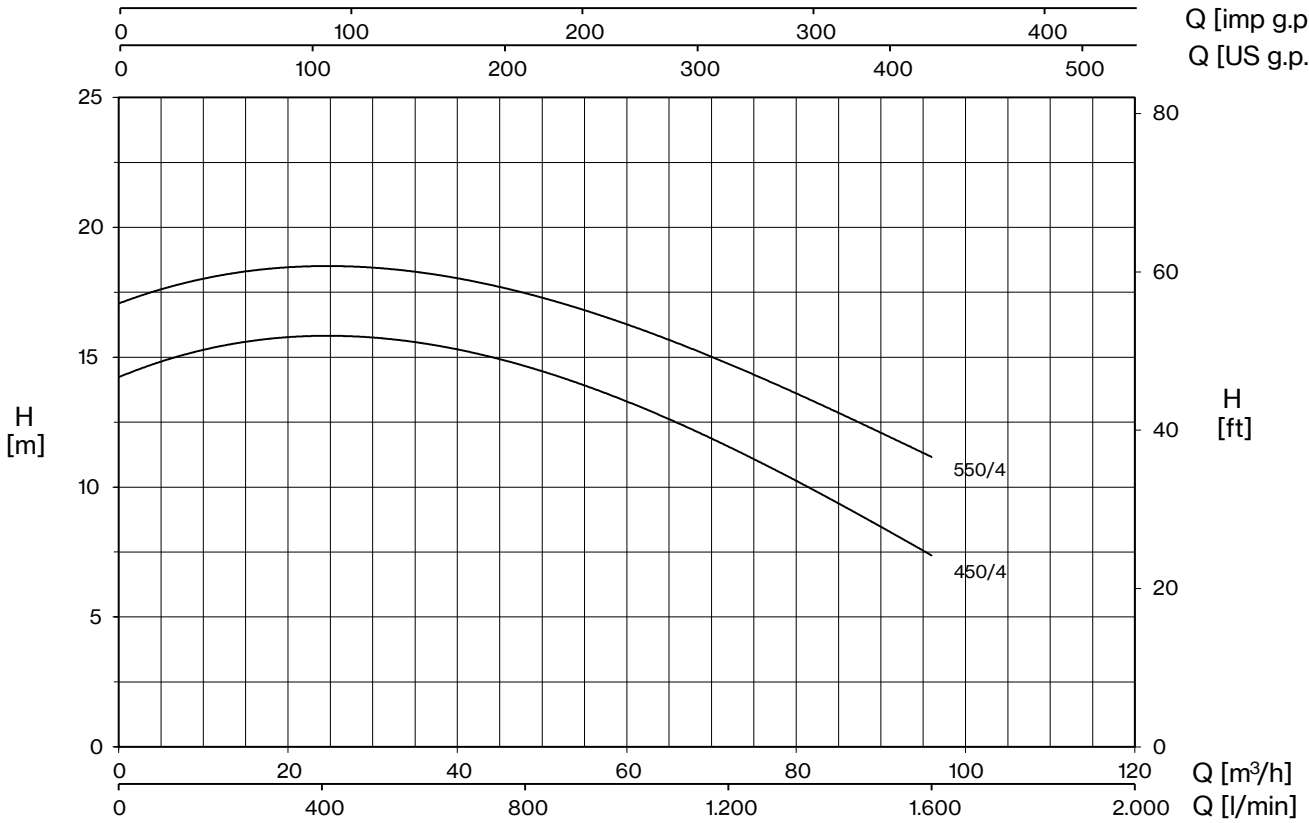

TYPE		P2		P1 (kW)		AMPERE		Q (m³/h - l/min)						
1~	3~	HP	kW	1~	3~	1x230 V 50 Hz	3x400 V 50 Hz	0	36	48	60	72	84	96
								0	600	800	1000	1200	1400	1600
								H (m)						
SD 450/4	SD 450/4 T	4	3	3,6	3,6	16,1	6,5	14,2	15,5	14,7	13,4	11,5	9,6	7,4
-	SD 550/4 T	5,5	4	-	4,7	-	8,5	17,1	18,3	17,4	16,3	14,7	13,1	11,1

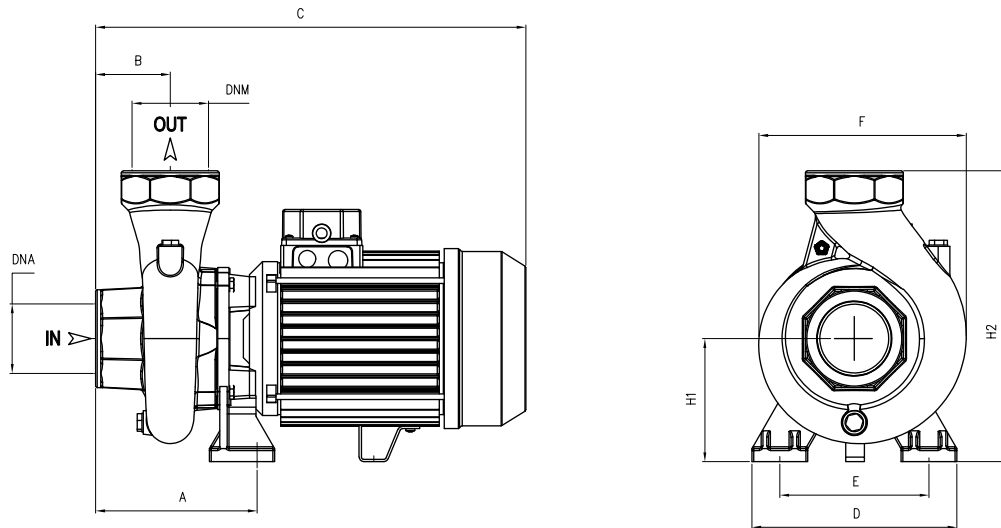

TYPE	DIMENSIONS (mm)														
	A	B	C	D	E	F	H1	H2	DNA	DNM	I	L	M	kg	T
SD 75/2	127	45	315	155	115	178	97	247	2" G	2" G	340	195	280	14,5	T 14
SD 100/2	127	45	315	155	115	178	97	247			340	195	280	16	T 25
SD 120/2	127	45	315	155	115	178	97	247			340	195	280	16,5	T 16
SDB 100/2	130	70	365	180	130	195	90	240			390	230	325	19	
SDB 150/2	130	70	365	180	130	195	90	240	390	230	325	20	T 19		
SD 150/2	150	53	370	180	140	218	115	285	2" G	2" G	390	230	325	24,5	T 23,5
SD 200/2	150	53	370	180	140	218	115	285			390	230	325	25	T 24,5
SD 200/3	176,5	80	485	200	140	225	112	292	3" G	3" G	520	235	320	29	T 28
SD 300/3	176,5	80	485	200	140	225	112	292			520	235	320	32,5	T 30
SD 400/3 T	176,5	80	485	200	140	225	112	292			520	235	320	32,5	
SD 450/4	165	85	515	220	160	250	130	330	4" G	4" G	546	265	355	46	T 42
SD 550/4 T	165	85	515	220	160	250	130	330			546	265	355	46	