

L line



L Legend:

6 L R G * 36 / 12 - 4 --

- 6 → Pump size in inches
- L → Family name
- R → Radial version
M → Semi-axial version
- G → Cast Iron execution
S → AISI 304 execution
X → AISI 316 execution
D → Duplex execution
L → AISI 904L execution
- * → Lowercase letter, is shown only if impeller material is different than pump (ex. d=Duplex)
- 36 → Nominal flow (m³/h) at BEP
- 12 → Pump Stage number
- 4 → 4 ** = Motor Flange
- → Motor model if included

* = Lowercase letter, is shown only if impeller material is different than pump (ex. d=Duplex)

4** = Motor flange size, it is not shown if it is the same of the pump

Submersible multistage centrifugal pumps for 4" wells with sand-resistant floating impellers. Check valve built into the delivery outlet. Pump flange for coupling with motors are made according to NEMA standards. Most common applications are civil and agricultural.



Construction features

Delivery outlet and bracket	stainless steel AISI 304
External jacket	stainless steel AISI 304
Impellers	polycarbonate Lexan
Diffusers	polycarbonate Noryl®
Upper bushings	NBR rubber
Shaft	stainless steel AISI 420
Quantity of sand in the water	max 300 g/m ³
Max liquid temperature	35° C



4L

4L 2

Motor 50 Hz - 2900 rpm							Q							
TYPE	Power		1~ 230 V		400 V	I/min	0	5	10	15	20	25	30	35
						I/sec	0	0,08	0,17	0,25	0,33	0,42	0,50	0,58
	HP	kW	A	μF	A	m³/h	0	0,3	0,6	0,9	1,2	1,5	1,8	2,1
4L 2/08	0,5	0,37	3,5	16	1,2	H[m]	46	45	44	42	38	33	27	21
4L 2/13	0,75	0,55	4,9	20	1,7		74	73	71	68	62	54	44	33
4L 2/17	1	0,75	6,5	30	2,2		97	96	93	89	81	70	58	44
4L 2/25	1,5	1,1	9,4	40	3		143	141	137	131	119	104	85	64
4L 2/34	2	1,5	11,5	50	4		194	191	187	178	162	141	116	87
4L 2/50	3	2,2	14,7	75	5,7		286	281	274	261	239	207	170	129

4L 3

Motor 50 Hz - 2900 rpm							Q					
TYPE	Power		1~ 230 V		400 V	I/min	0	20	30	40	50	60
						I/sec	0	0,33	0,50	0,67	0,83	1,00
	HP	kW	A	μF	A	m³/h	0	1,2	1,8	2,4	3	3,6
4L 3/07	0,5	0,37	3,5	16	1,2	H[m]	46	40	36	31	24	15
4L 3/10	0,75	0,55	4,9	20	1,7		66	57	52	44	35	22
4L 3/14	1	0,75	6,5	30	2,2		92	80	73	62	49	31
4L 3/21	1,5	1,1	9,4	40	3		138	120	109	93	73	46
4L 3/28	2	1,5	11,5	50	4		184	160	145	124	97	61
4L 3/41	3	2,2	14,7	75	5,7		269	234	213	182	143	90
4L 3/56	4	3			7,4		368	320	291	248	195	123
4L 3/70	5,5	4			10		460	400	363	310	243	153

4L 4

Motor 50 Hz - 2900 rpm							Q								
TYPE	Power		1~ 230 V		400 V	I/min	0	20	30	40	50	60	70	80	90
						I/sec	0	0,33	0,50	0,67	0,83	1,00	1,17	1,33	1,50
	HP	kW	A	μF	A	m³/h	0	1,2	1,8	2,4	3	3,6	4,2	4,8	5,4
4L 4/07	0,75	0,55	4,9	20	1,7	H[m]	46	46	44	41	37	32	27	20	12
4L 4/10	1	0,75	6,5	30	2,2		66	65	63	59	53	46	38	28	18
4L 4/14	1,5	1,1	9,4	40	3		93	91	88	82	74	65	53	39	25
4L 4/20	2	1,5	11,5	50	4		133	130	126	118	106	93	76	56	35
4L 4/29	3	2,2	14,7	75	5,7		192	189	183	170	154	134	111	82	51
4L 4/39	4	3			7,4		258	254	246	229	207	180	149	110	68
4L 4/52	5,5	4			10		345	338	328	306	276	241	198	146	91

Motor 50 Hz - 2900 rpm							Q							
TYPE	Power		1~ 230 V		400 V	I/min	0	40	50	60	70	80	90	100
						I/sec	0	0,67	0,83	1,00	1,17	1,33	1,50	1,67
	HP	kW	A	μF	A	m³/h	0	2,4	3	3,6	4,2	4,8	5,4	6
4L 5/06	0,75	0,55	4,9	20	1,7	H[m]	41	38	36	34	30	25	19	12
4L 5/08	1	0,75	6,5	30	2,2		55	51	49	45	40	34	26	17
4L 5/12	1,5	1,1	9,4	40	3		83	77	73	68	60	50	38	25
4L 5/16	2	1,5	11,5	50	4		110	102	97	90	80	67	51	33
4L 5/23	3	2,2	14,7	75	5,7		158	147	139	129	115	96	73	47
4L 5/32	4	3			7,4		220	204	194	180	160	134	102	66
4L 5/42	5,5	4			10		289	268	255	236	210	176	134	87
4L 5/52	7,5	5,5			13,5		358	332	315	293	260	218	166	107
4L 5/68	10	7,5			18		468	434	412	383	340	285	217	140

Motor 50 Hz - 2900 rpm							Q							
TYPE	Power		1~ 230 V		400 V	I/min	0	40	60	80	100	120	140	160
						I/sec	0	0,67	1,00	1,33	1,67	2,00	2,33	2,67
	HP	kW	A	μF	A	m³/h	0	2,4	3,6	4,8	6	7,2	8,4	9,6
4L 7/04	0,75	0,55	4,9	20	1,7	H[m]	26	24	23	22	20	17	14	10
4L 7/06	1	0,75	6,5	30	2,2		38	36	34	32	30	26	21	14
4L 7/09	1,5	1,1	9,4	40	3		57	53	51	48	44	39	32	21
4L 7/12	2	1,5	11,5	50	4		77	71	68	65	59	52	42	29
4L 7/17	3	2,2	14,7	75	5,7		109	101	97	92	84	73	60	41
4L 7/23	4	3			7,4		147	136	131	124	113	99	81	55
4L 7/31	5,5	4			10		198	184	176	167	153	134	110	74
4L 7/42	7,5	5,5			13,5		268	249	239	226	207	181	149	100
4L 7/56	10	7,5			18		358	332	319	302	276	241	198	134

Motor 50 Hz - 2900 rpm							Q							
TYPE	Power		1~ 230 V		400 V	I/min	0	80	100	120	140	160	180	200
						I/sec	0	1,33	1,67	2,00	2,33	2,67	3,00	3,33
	HP	kW	A	μF	A	m³/h	0	4,8	6	7,2	8,4	9,6	10,8	12
4L 9/04	1	0,75	6,5	30	2,2	H[m]	25	24	22	21	18	15	11	4
4L 9/07	1,5	1,1	9,4	40	3		44	41	39	36	32	27	19	8
4L 9/09	2	1,5	11,5	50	4		56	53	50	46	42	35	25	10
4L 9/13	3	2,2	14,7	75	5,7		81	77	72	67	60	50	36	14
4L 9/18	4	3			7,4		112	107	100	93	83	69	50	19
4L 9/24	5,5	4			10		150	142	133	124	111	92	66	26
4L 9/31	7,5	5,5			13,5		193	184	172	160	143	119	86	33
4L 9/42	10	7,5			18		262	249	233	216	194	162	116	45

4L

4L 10

Motor 50 Hz - 2900 rpm							Q							
TYPE	Power		1~ 230 V		400 V	I/min	0	100	125	150	175	200	225	250
	HP	kW	A	μF		A	I/sec	0	1,67	2,08	2,50	2,92	3,33	3,75
					m³/h		0	6	7	9	10,5	12	13,5	15
4L 10/04	1	0,75	6,5	30	2,2	H[m]	31	24	22	20	18	14	12	9
4L 10/05	1,5	1,1	9,4	40	3		39	30	28	25	22	18	15	11
4L 10/07	2	1,5	11,5	50	4		54	42	39	35	31	25	21	15
4L 10/10	3	2,2	14,7	75	5,7		77	60	55	50	44	36	30	22
4L 10/14	4	3			7,4		108	83	77	70	62	50	42	31
4L 10/19	5,5	4			10		146	113	105	95	84	68	57	42
4L 10/26	7,5	5,5			13,5		200	155	143	130	114	94	78	57
4L 10/35	10	7,5			18		270	208	193	175	154	126	105	77

4L 12

Motor 50 Hz - 2900 rpm							Q							
TYPE	Power		1~ 230 V		400 V	I/min	0	150	175	200	225	250	275	300
	HP	kW	A	μF		A	I/sec	0	2,50	2,92	3,33	3,75	4,17	4,58
					m³/h		0	9	10,5	12	13,5	15,0	16,5	18
4L 12/04	1,5	1,1	9,4	40	3	H[m]	28	22	20	17	15	12	8	4
4L 12/05	2	1,5	11,5	50	4		35	28	26	22	18	15	10	5
4L 12/07	3	2,2	14,7	75	5,7		49	39	36	30	26	21	14	7
4L 12/10	4	3			7,4		70	56	51	43	37	29	20	9
4L 12/13	5,5	4			10		91	72	66	56	48	38	26	12
4L 12/18	7,5	5,5			13,5		126	100	92	78	66	53	36	17
4L 12/24	10	7,5			18		168	133	123	104	88	71	48	23

4L 16

Motor 50 Hz - 2900 rpm							Q						
TYPE	Power		1~ 230 V		400 V	I/min	0	150	200	250	300	350	400
	HP	kW	A	μF		A	I/sec	0	2,50	3,33	4,17	5,00	5,83
					m³/h		0	9	12	15	18	21	24
4L 16/05	1,5	1,1	9,4	40	3	H[m]	28	22	19	17	14	9	2,2
4L 16/07	2	1,5	11,5	50	4		39	30	27	24	19	12	3,1
4L 16/10	3	2,2	14,7	75	5,7		56	43	39	34	27	17	4,4
4L 16/14	4	3			7,4		78	61	54	48	38	24	6
4L 16/19	5,5	4			10		106	82	74	65	52	33	8
4L 16/23	7,5	5,5			13,5		128	100	89	79	63	40	10
4L 16/32	10	7,5			18		178	139	124	110	87	55	14

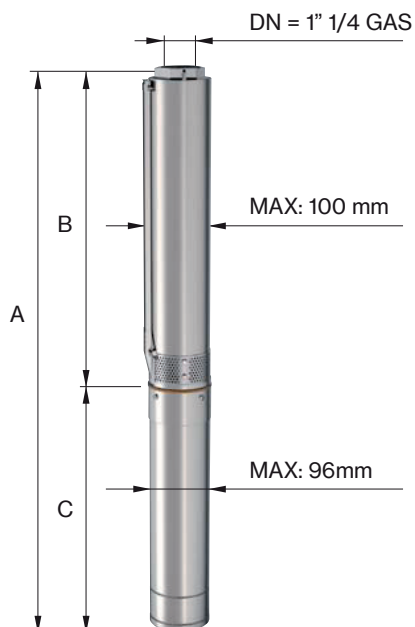

4L 2

Motor 50 Hz 2900 rpm	DIMENSIONS (mm)					Weight (kg)		
TYPE	A 1- 230 V	A 3- 400 V	B	C 1-	C 3-	M 1-	M 3-	P
4L 2/08	683	-	366	317	-	7	-	4
4L 2/13	801	781	464	337	317	8	8	5
4L 2/17	904	879	542	362	337	10	10	6
4L 2/25	1090	1060	698	392	362	12	12	8
4L 2/34	1295	1265	873	422	392	13	13	11
4L 2/50	1652	1637	1185	467	452	15	15	15

Max Eff. % =	40,5	Q (flow)	25%	50%	75%	100%
Max kW / St. =	0,044	NPSH (m)	2	2	2,2	2,7

4L 3

Motor 50 Hz 2900 rpm	DIMENSIONS (mm)					Weight (kg)		
TYPE	A 1- 230 V	A 3- 400 V	B	C 1-	C 3-	M 1-	M 3-	P
4L 3/07	681	-	364	317	-	7	-	4
4L 3/10	767	747	430	337	317	8	8	5
4L 3/14	880	855	518	362	337	10	10	6
4L 3/21	1064	1034	672	392	362	12	12	7
4L 3/28	1248	1218	826	422	392	13	13	9
4L 3/41	1579	1564	1112	467	452	15	15	12
4L 3/56	-	1999	1442	-	557	-	19	16
4L 3/70	-	2347	1750	-	597	-	22	20

Max Eff. % =	56	Q (flow)	25%	50%	75%	100%
Max kW / St. =	0,053	NPSH (m)	2	2	2,5	3,2

4L

4L 4

Motor 50 Hz 2900 rpm	DIMENSIONS (mm)					Weight (kg)		
TYPE	A 1- 230 V	A 3- 400 V	B	C 1-	C 3-	M 1-	M 3-	P
4L 4/07	701	681	364	337	317	8	8	4
4L 4/10	792	767	430	362	337	10	10	5
4L 4/14	910	880	518	392	362	12	12	6
4L 4/20	1072	1042	650	422	392	13	13	7
4L 4/29	1315	1300	848	467	452	15	15	10
4L 4/39		1625	1068		557		19	12
4L 4/52		1951	1354		597		22	16

Max Eff. % =	64
Max kW / St. =	0,076

Q (flow)	25%	50%	75%	100%
NPSH (m)	2	2	2,5	3,2

4L 5

Motor 50 Hz 2900 rpm	DIMENSIONS (mm)					Weight (kg)		
TYPE	A 1- 230 V	A 3- 400 V	B	C 1-	C 3-	M 1-	M 3-	P
4L 5/06	679	659	342	337	317	8	8	4
4L 5/08	748	723	386	362	337	10	10	4,5
4L 5/12	866	836	474	392	362	12	12	6
4L 5/16	984	954	562	422	392	13	13	7
4L 5/23	1183	1168	716	467	452	15	15	9
4L 5/32		1471	914		557		19	12
4L 5/42		1731	1134		597		22	15
4L 5/52		2052	1354		698		27	18
4L 5/68		2524	1706		818		32	23

Max Eff. % =	63,5
Max kW / St. =	0,095

Q (flow)	25%	50%	75%	100%
NPSH (m)	2	2	2,5	3,2

4L 7

Motor 50 Hz 2900 rpm	DIMENSIONS (mm)					Weight (kg)		
TYPE	A 1- 230 V	A 3- 400 V	B	C 1-	C 3-	M 1-	M 3-	P
4L 7/04	667	647	330	337	317	8	8	3
4L 7/06	752	727	390	362	337	10	10	4
4L 7/09	872	842	480	392	362	12	12	5
4L 7/12	992	962	570	422	392	13	13	6
4L 7/17	1187	1172	720	467	452	15	15	8
4L 7/23		1457	900		557		19	10
4L 7/31		1737	1140		597		22	13
4L 7/42		2168	1470		698		27	16
4L 7/56		2708	1890		818		32	21

Max Eff. % =	65
Max kW / St. =	0,128

Q (flow)	25%	50%	75%	100%
NPSH (m)	2	2	2,7	3,5

Motor 50 Hz 2900 rpm	DIMENSIONS (mm)					Weight (kg)		
TYPE	A 1- 230 V	A 3- 400 V	B	C 1-	C 3-	M 1-	M 3-	P
4L 9/04	692	667	330	362	337	10	10	3
4L 9/07	812	782	420	392	362	12	12	4
4L 9/09	902	872	480	422	392	13	13	5
4L 9/13	1067	1052	600	467	452	15	15	6
4L 9/18		1307	750		557		19	8
4L 9/24		1527	930		597		22	10
4L 9/31		1838	1140		698		27	12
4L 9/42		2288	1470		818		32	16

Max Eff. % =	64
Max kW / St. =	0,165

Q (flow)	25%	50%	75%	100%
NPSH (m)	2,2	2,2	3	4,8

Motor 50 Hz 2900 rpm	DIMENSIONS (mm)					Weight (kg)		
TYPE	A 1- 230 V	A 3- 400 V	B	C 1-	C 3-	M 1-	M 3-	P
4L 10/04	736	711	374	362	337	10	10	4
4L 10/05	807	777	415	392	362	12	12	4
4L 10/07	919	889	497	422	392	13	13	5
4L 10/10	1087	1072	620	467	452	15	15	6
4L 10/14		1341	784		557		19	7
4L 10/19		1586	989		597		22	9
4L 10/26		1974	1276		698		27	12
4L 10/35		2463	1645		818		32	15

Max Eff. % =	60
Max kW / St. =	0,210

Q (flow)	25%	50%	75%	100%
NPSH (m)	2,2	2,2	3	4,8

Motor 50 Hz 2900 rpm	DIMENSIONS (mm)					Weight (kg)		
TYPE	A 1- 230 V	A 3- 400 V	B	C 1-	C 3-	M 1-	M 3-	P
4L 12/04	766	736	374	392	362	12	12	4
4L 12/05	837	807	415	422	392	13	13	4
4L 12/07	964	949	497	467	452	15	15	5
4L 12/10		1177	620		557		19	6
4L 12/13		1340	743		597		22	7
4L 12/18		1646	948		698		27	9
4L 12/24		2012	1194		818		32	12

Max Eff. % =	57
Max kW / St. =	0,308

Q (flow)	25%	50%	75%	100%
NPSH (m)	2,2	2,2	3	4,8

4L

4L 16

Motor 50 Hz 2900 rpm	DIMENSIONS (mm)					Weight (kg)		
TYPE	A 1- 230 V	A 3- 400 V	B	C 1-	C 3-	M 1-	M 3-	P
4L 16/05	967	937	575	392	362	12	12	5
4L 16/07	1143	1113	721	422	392	13	13	6
4L 16/10	1407	1392	940	467	452	15	15	8
4L 16/14		1789	1232		557		19	10
4L 16/19		2194	1597		597		22	13
4L 16/23		2587	1889		698		27	16
4L 16/32		3364	2546		818		32	21

Max Eff. % =	64,5
Max kW / St. =	0,216

Q (flow)	25%	50%	75%	100%
NPSH (m)	3	3	4	6

4L

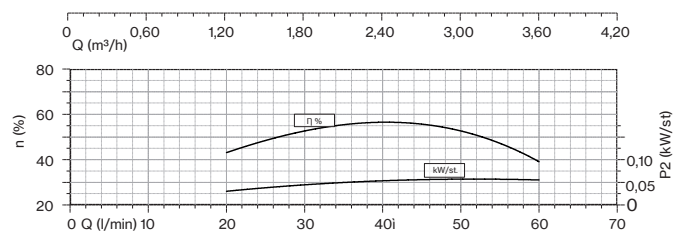
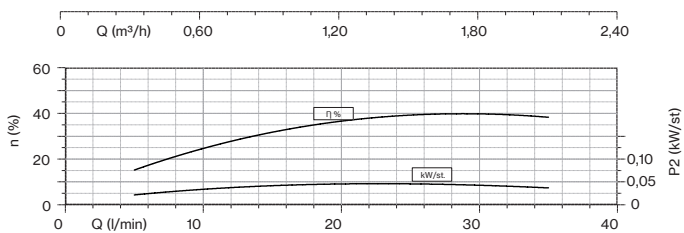
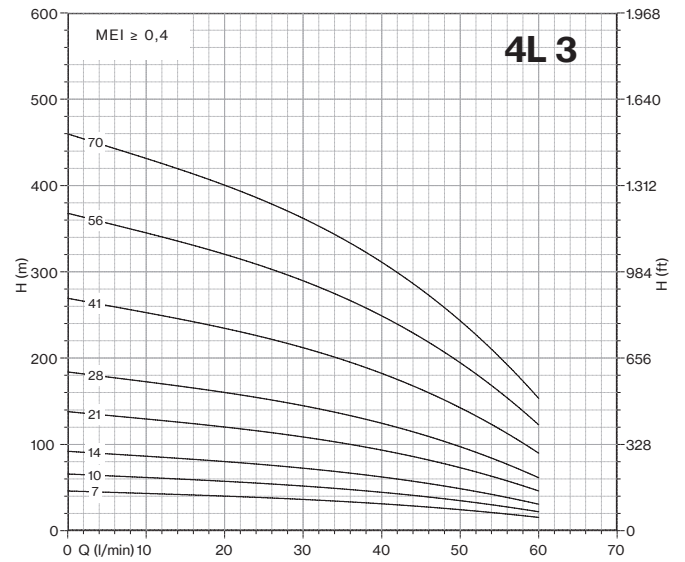
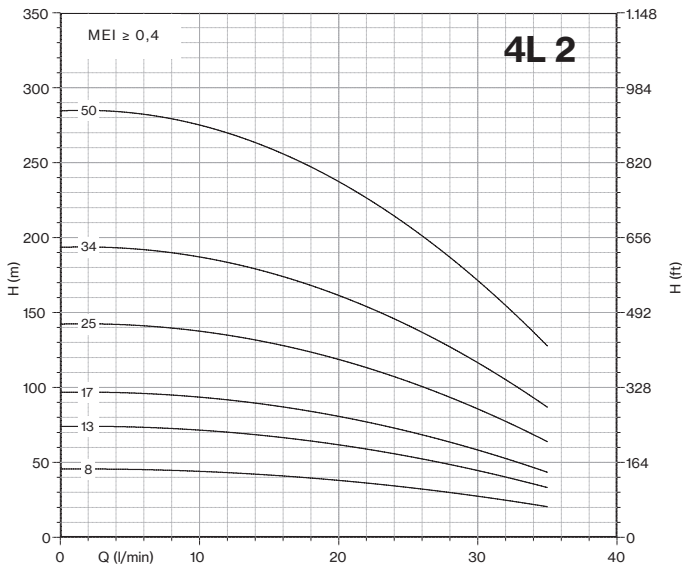

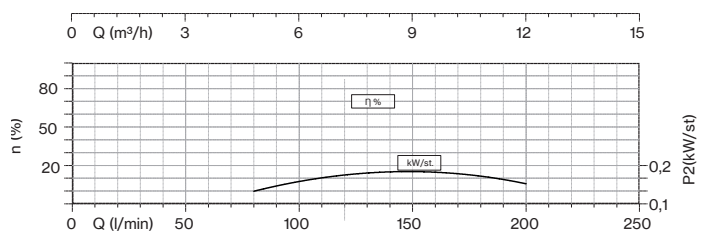
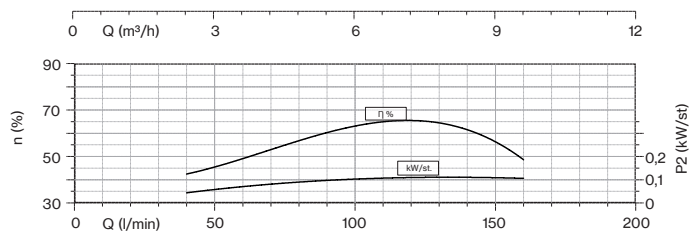
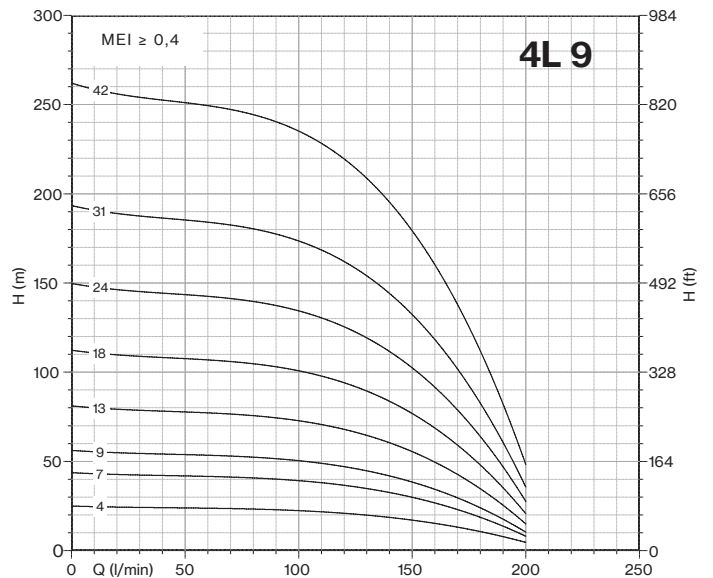
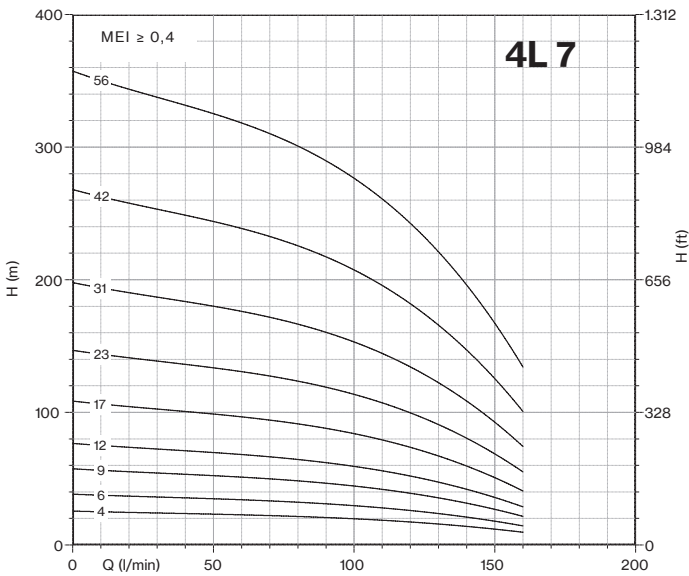
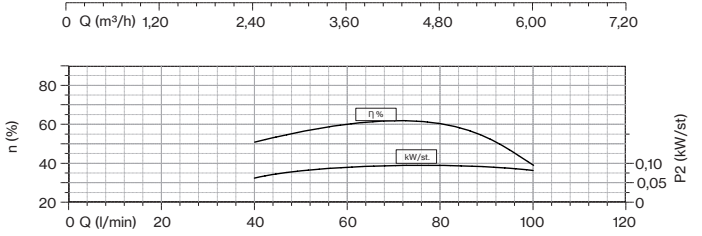
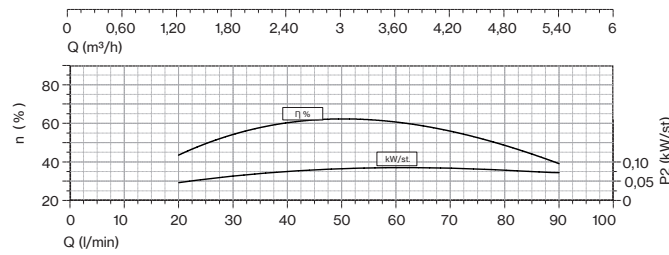
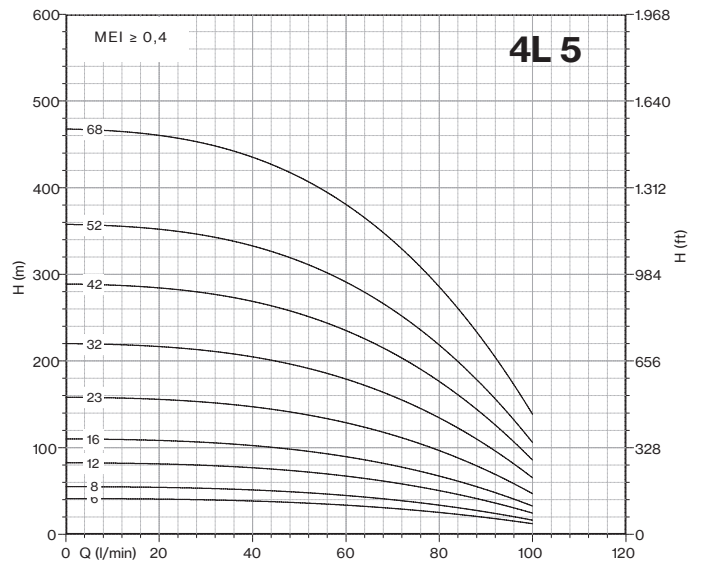
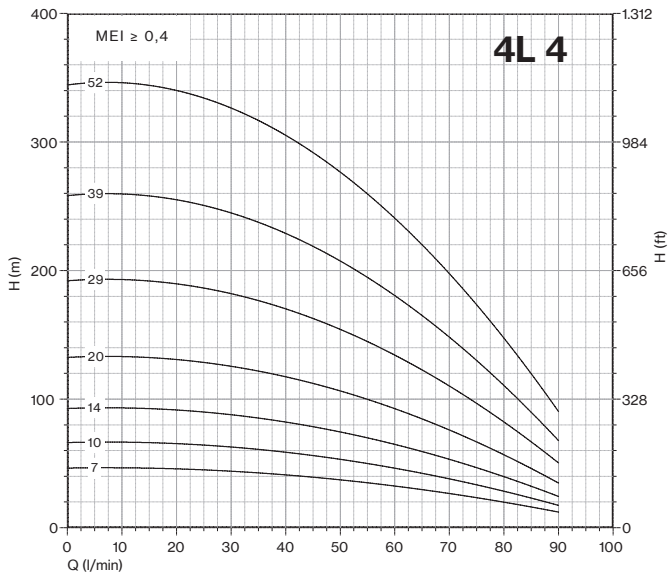

4L

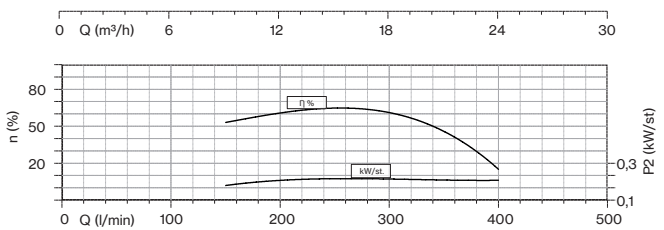
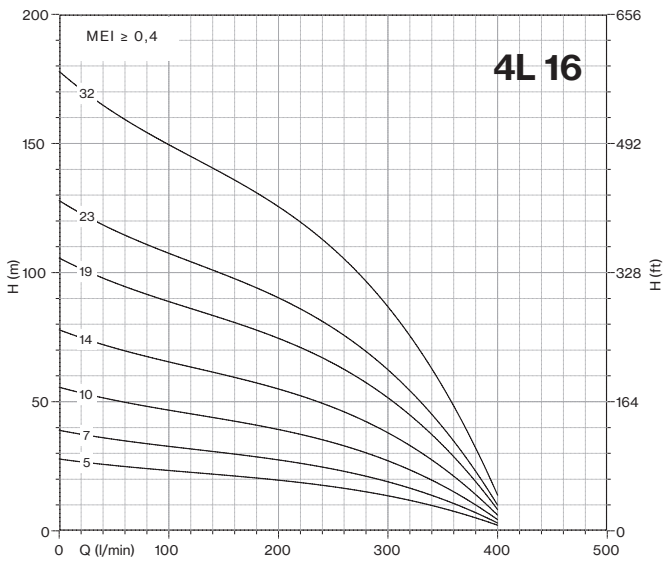
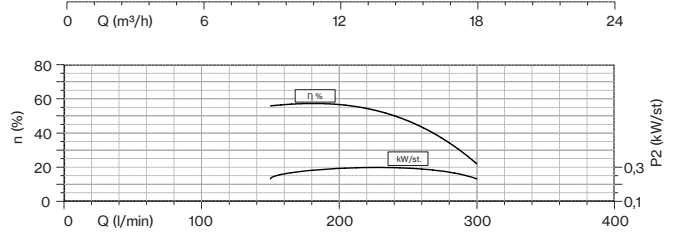
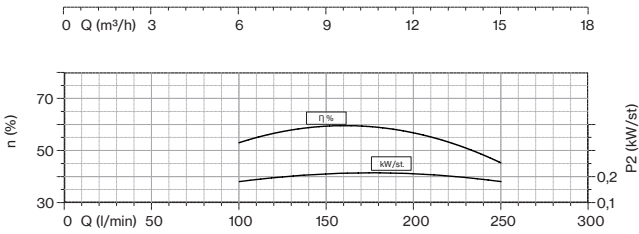
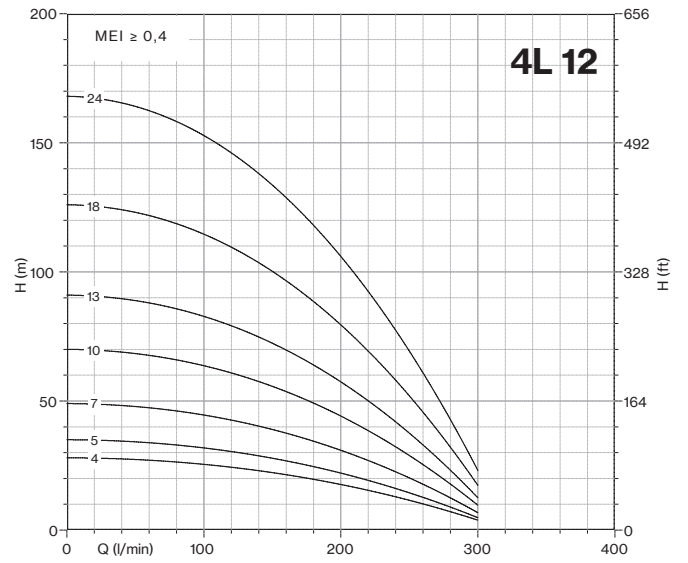
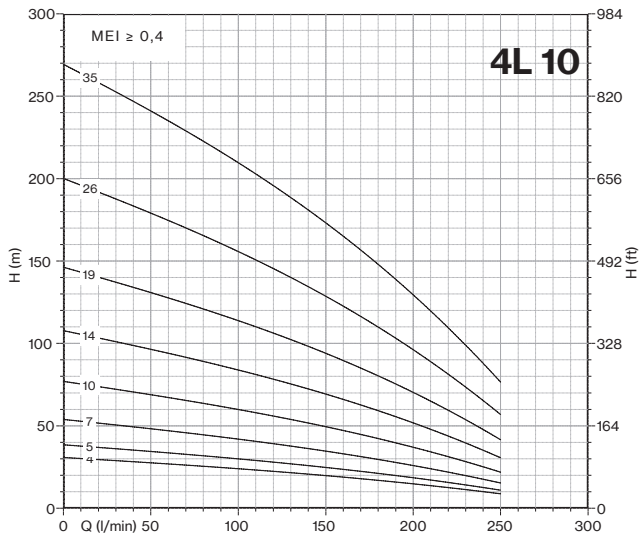

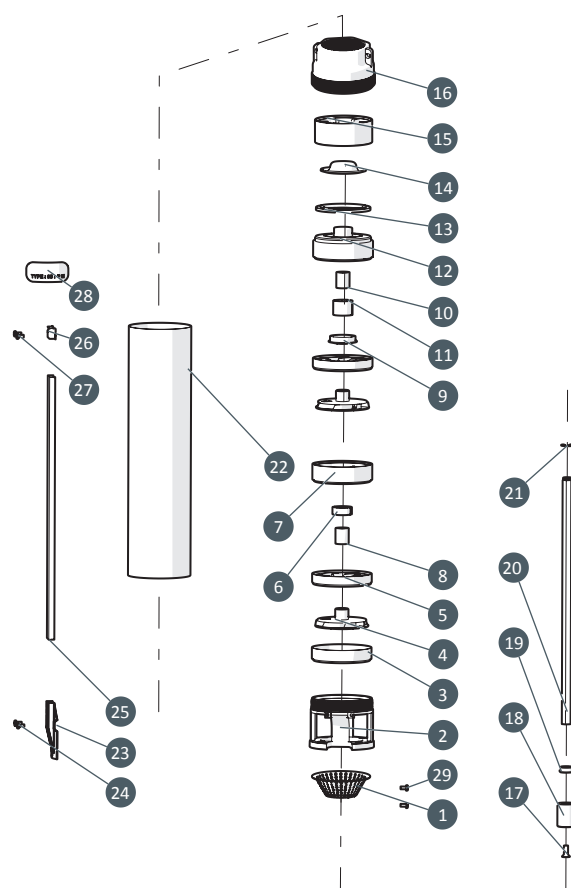

N. CODE	DESCRIPTION	MATERIAL
1	SUCTION STRAINER	AISI 304
2	SUCTION CAGE	AISI 304
3	INTERMEDIATE CASING	AISI 304
4	IMPELLER	POLYCARBONATE
5	DIFFUSEUR	NORYL GFN2
6	INTERMEDIATE BEARING BUSH	RUBBER NBR
7	INTERMEDIATE SUPPORT	NORYL GFN2
8	INTERMEDIATE SPACER	AISI 304
9	SAND GUARD	NORYL GFN2
10	SPACER UPPER SUPPORT	AISI 304
11	UPPER BEARING BUSH	RUBBER NBR
12	UPPER SUPPORT	NORYL GFN2
13	GASLET VALVE	RUBBER NBR
14	CAP VALVE	AISI 304
15	RING CONNECTOR DELIVERY BOWL	NORYL GFN2
16	DELIVERY BOWL	AISI 304
17	SCREW M6X12	AISI 304
18	FLOTTANTE FLOATING JOINT	AISI 304
19	SPACER FIRST IMPELLER	POLYCARBONATE
20	PUMP SHAFT	AISI 420
21	SEEGER	AISI 304
22	SLEEVE	AISI 304
23	LOWER FLANGE	AISI 304
24	N.2 SCREW M4X10 FOR LOWER FLANGE	AISI 304
25	COVER CABLE	AISI 304
26	UPPER FLANGE	AISI 304
27	N.2 SCREW M4X10 FOR UPPER FLANGE	AISI 304
28	ADHESIVE LABEL	POLYESTER
29	N.2 SCREW M4X10 SUCTION STRAINER	AISI 304